

环保物料

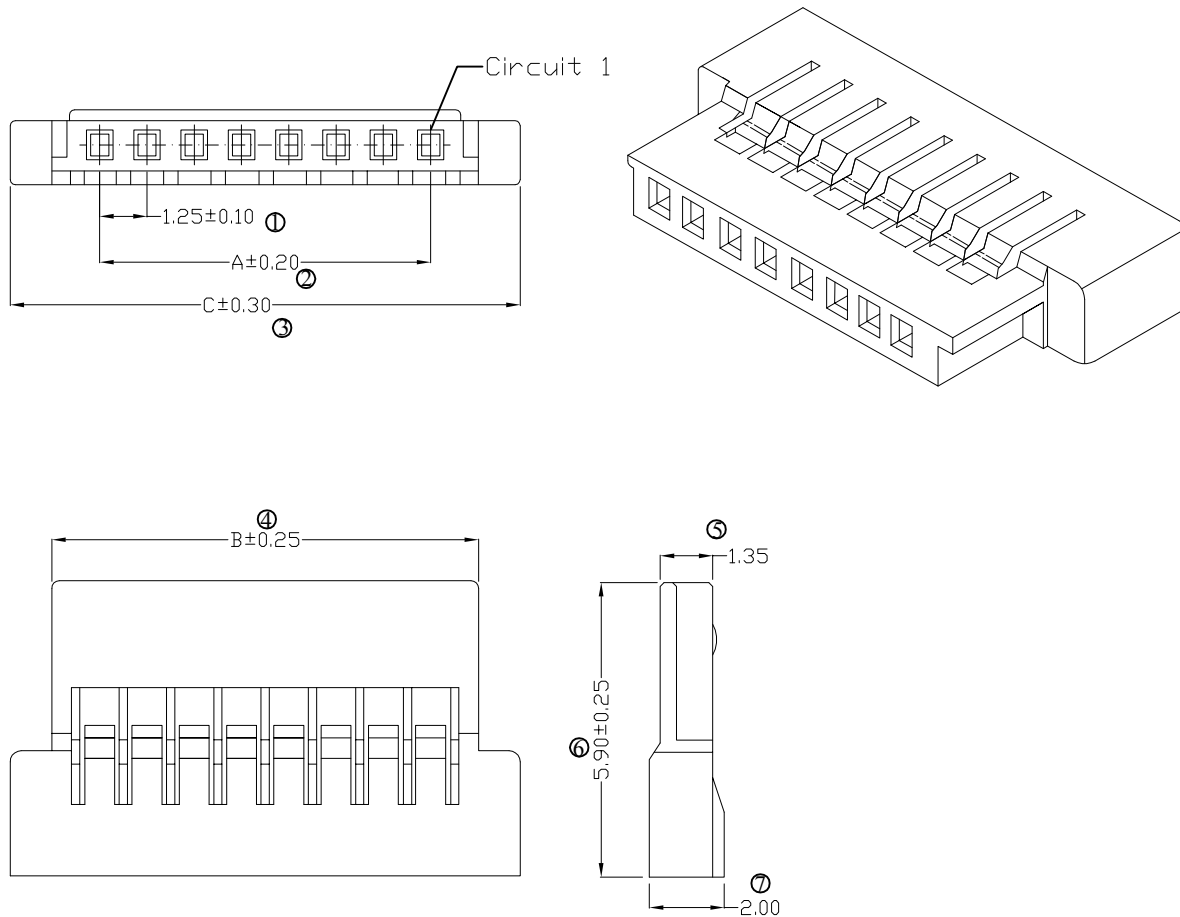

■ Specifications(规格) :

- Voltage rating(额定电压): 200V AC / DC
- Current rating(额定电流): 1A AC / DC
- Withstanding voltage(耐压值): 500V AC/minute
- Temperature range(工作温度): -25°C~+85°C
- Insulation resistance(绝缘电阻): ≥100MΩ
- Contact resistance(接触电阻): ≤40mΩ
- After environmental testing(环境测试后): ≤50mΩ

■ Housing(胶壳)

- Part No. (料号) :J1256H-XXP
- Poles (PIN数) : 02-30
- Material (材质) : Nylon 66 (尼龙66) UL 94V-0
- Suitable HLB J1256T Series Terminal(匹配J1256T系列端子)
- Mates With HLB J1256WR Series Wafer (匹配J1256WR系列针座)
- Q' ty (数量) : 1,000Pcs/Bag/每袋 (1,000Pcs)

PART NO.	Dimensions (mm)		
	A	B	C
J1256H-02PA	1.25	3.80	6.00
J1256H-03PA	2.50	5.05	7.25
J1256H-04PA	3.75	6.30	8.50
J1256H-05PA	5.00	7.55	9.75
J1256H-06PA	6.25	8.80	11.00
J1256H-08PA	8.75	11.30	13.50
J1256H-10PA	11.25	13.80	16.00
J1256H-15PA	17.50	20.05	22.25
J1256H-20PA	23.75	26.30	28.50
J1256H-25PA	30.00	32.55	34.75
J1256H-30PA	36.25	38.80	41.00

						<p>一般公差 GENERAL TOLERANCE</p> <p>. X ±0.3</p> <p>. XX ±0.2</p> <p>. XXX ±0.1</p>				<p>东莞市翰皓精密电子有限公司 Dongguan HanHao Precision Electronics Co.,Ltd</p>				<p>料号 PART NO J1256H-XXP</p>			
										<p>品名 TITLE 1.25 mm Crimp Style connectors</p>							
2011/05/14	A	B	修改图框格式					核准 APPD	审核 CHK	绘图 DR	日期 DATA						
日期 DATE	旧版次 OLD REV	新版次 NEW REV	变更内容 DESCRIPTION			审核 CHK	核准 APPD	角法	PROJECT	DONGKUN	SUCCESS	刘艳	2007/05/03	单位 UNIT MM	比例 SCALE 1/1	图号 NUMBER A-106	版次 REV B

环保物料

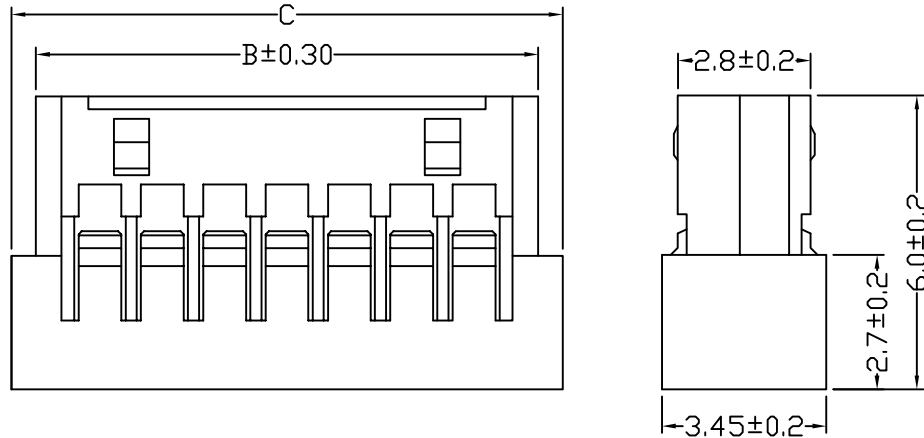
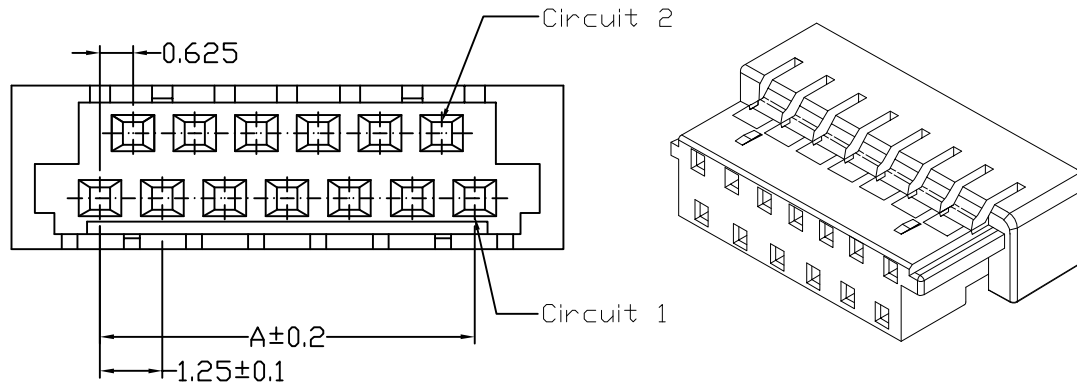

■ Specifications(规格) :

- Voltage rating(额定电压): 200V AC / DC
- Current rating(额定电流): 1A AC / DC
- Withstanding voltage(耐压值): 500V AC/minute
- Temperature range(工作温度): -25°C~+85°C
- Insulation resistance(绝缘电阻):  $\geq 100M\Omega$
- Contact resistance(接触电阻):  $\leq 40m\Omega$
- After environmental testing(环境测试后):  $\leq 50m\Omega$

■ Housing(胶壳)

- Part No. (料号) : J1257H-2\*XX
- Poles(PIN数) : 05-41
- Material (材质) : Nylon 66 (尼龙66) UL 94V-0
- Suitable HLB J1256T Series Terminal(匹配J1256T系列端子)
- Mates With HLB J1257 Series Dual Row Wafer (匹配J1257WRS-2\*XX 双排系列针座)
- Q'ty (数量) : 1,000Pcs/Bag/每袋 (1,000Pcs)

Poles	PART NO.	Dimensions (mm)		
		A	B	C
05	J1257H-05PA-1	2.50	4.90	6.00
07	J1257H-07PA-1	3.75	6.15	7.25
09	J1257H-09PA-1	5.00	7.40	8.50
11	J1257H-11PA-1	6.25	8.65	9.75
13	J1257H-13PA-1	7.50	9.90	11.00
15	J1257H-15PA-1	8.75	11.15	12.25
17	J1257H-17PA-1	10.00	12.40	13.50
19	J1257H-19PA-1	11.25	13.65	14.75
21	J1257H-21PA-1	12.50	14.90	16.00
31	J1257H-31PA-1	18.75	21.15	22.25
41	J1257H-41PA-1	25.00	27.40	28.50

						一般公差 GENERAL TOLERANCE		东莞市翰皓精密电子有限公司 Dongguan HanHao Precision Electronics Co.,Ltd		料号 PART NO J1257JH-XX						
										品名 TITLE 1.25 mm Crimp Style connectors						
2011/05/14	A	B	修改图框格式					核准 APPD	审核 CHK	绘图 DR	日期 DATA					
日期 DATE	旧版次 OLD REV	新版次 NEW REV	变更内容 DESCRIPTION			审核 CHK	核准 APPD	角法	PROJECT	SUCCESS	刘艳	2007/05/03	单位 UNIT MM	比例 SCALE 1/1	图号 NUMBER A-106	版次 REV B

环保物料

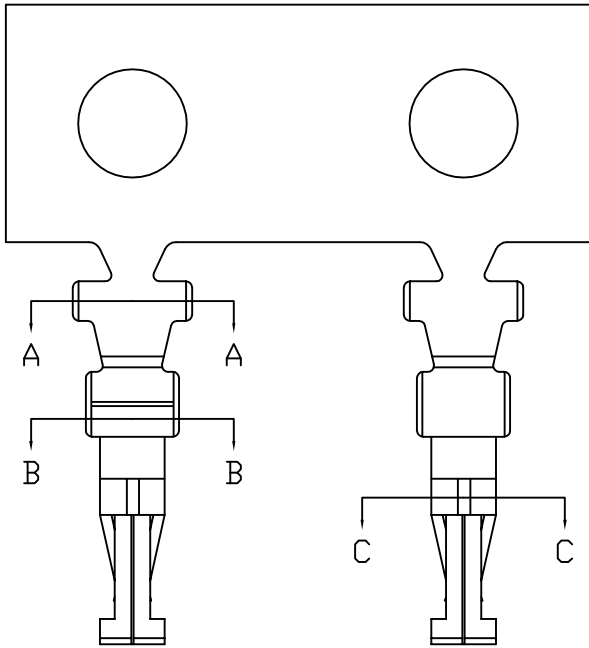

Section: A-A

Section: B-B

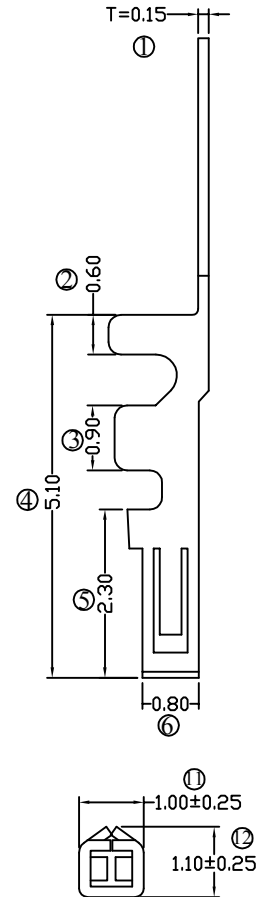
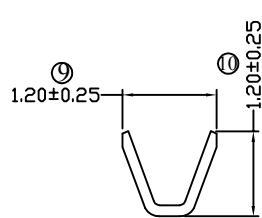
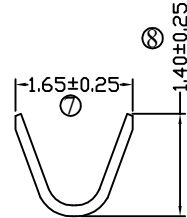

Section: C-C

Specifications

- Voltage rating : 200V AC/DC
- Current rating : 3A AC/DC
- Withstanding voltage : 500V AC/Minute
- Insulation resistance: 100MΩ Min
- Temperature range: -25°C~+85°C
- (Including temperature rise in applying electrical current)
- Contact resistance: Intial value/40mΩ Max

Terminal

- Part No. : J1256T
- Material : Phosphor Bronze
- Finish: Gold-flash
- Thickness : 0.2mm
- Used in HLB J1256 series Housing
- Q'ty : 10000 Pcs/Reel

						一般公差 GENERAL TOLERANCE		东莞市翰皓精密电子有限公司 Dongguan HanHao Precision Electronics Co.,Ltd				料号 PART NO J1256T				
						.X ±0.3 .XX ±0.2 .XXX ±0.1						品名 TITLE 1.25 mm Crimp Style connectors				
2011/05/14	A	B	修改图框格式					核准 APPD	审核 CHK	绘图 DR	日期 DATA	单位 UNIT	比例 SCALE	图号 NUMBER	版次 REV	
日期 DATE	旧版次 OLD REV	新版次 NEW REV	变更内容 DESCRIPTION			审核 CHK	核准 APPD	角法	PROJECT	DK	SUCCESS	刘艳	2007/05/03	MM	1: 4	A-070 B

环保物料

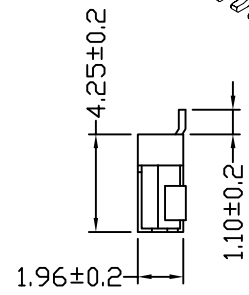
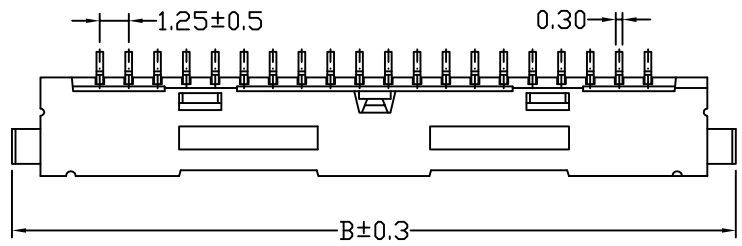
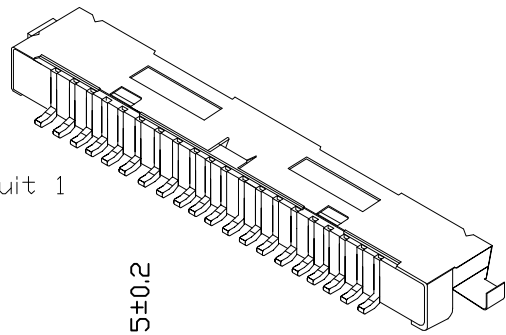
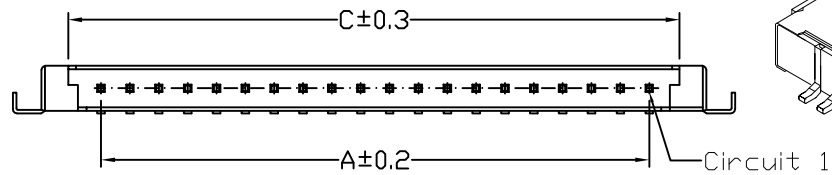

■ Specifications(规格) :

- Voltage rating(额定电压): 200V AC / DC
- Current rating(额定电流): 1A AC / DC
- Withstanding voltage(耐压值): 500V AC/minute
- Temperature range(工作温度): -25°C~+85°C
- Insulation resistance(绝缘电阻): ≥100MΩ
- Contact resistance(接触电阻): ≤40mΩ
- After environmental testing(环境测试后): ≤50mΩ

■ Wafer(针座)

- Part No. (料号) :J1256WR-XXP
- Poles(PIN数) :20、30
- Material (材质) :Housing(胶壳) :LCP UL 94V-0  
Pin针:Brass (黄铜)  
Finish (电镀) :Tin-Plated (镀锡)  
Shell (铜壳) :Brass (黄铜)  
Finish (电镀) :Tin-Plated (镀锡)
- Mates With HLB J1256H Series Housing  
(匹配J1256H系列胶壳)
- Q'ty (数量) : 1,000Pcs/Bag/每袋 (1,000Pcs)

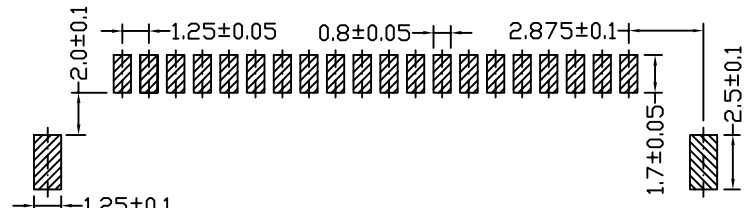

Recommand PCB Layout

Poles	Part No	Dimensions (mm)		
		A	B	C
20	J1256WR-20P	23.75	31.40	26.60
30	J1256WR-30P	36.25	43.90	39.10

							一般公差 GENERAL TOLERANCE .X ±0.3 .XX ±0.2 .XXX ±0.1				东莞市翰皓精密电子有限公司 Dongguan HanHao Precision Electronics Co.,Ltd				料号 PART NO J1256WRS-XXP			
											品名 TITLE 1.25 mm Crimp Style connectors							
2011/05/14	A	B	修改图框格式								核准 APPD	审核 CHK	绘图 DR	日期 DATA				
日期 DATE	旧版次 OLD REV	新版次 NEW REV	变更内容 DESCRIPTION				审核 CHK	核准 APPD	角法 PROJECT		DONGKUN	SUCCESS	刘艳	2007/05/03	单位 UNIT MM	比例 SCALE 1/1	图号 NUMBER A-106	版次 REV B

环保物料

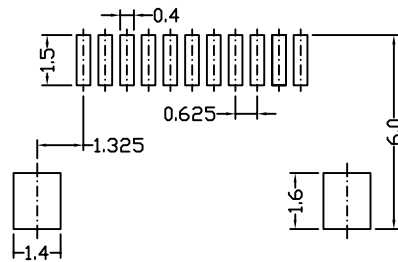
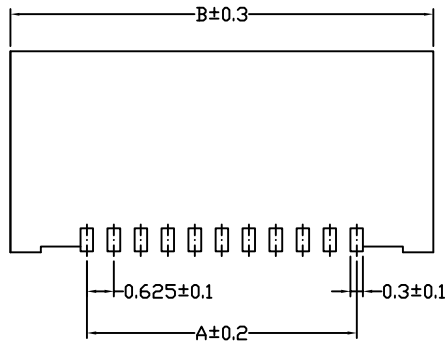
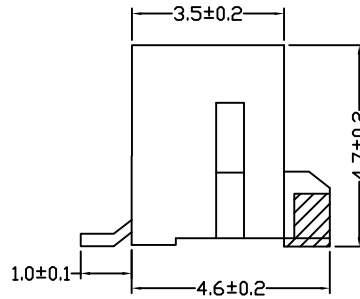
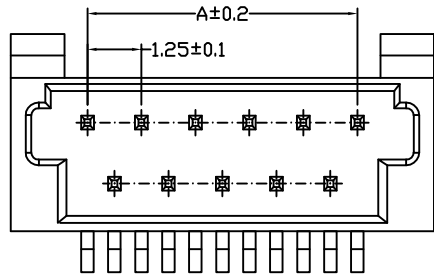

Recommand PCB Layout

Poles	Part No	Dimensions (mm)	
		A	B
5	1258W-05	2.50	6.10
7	1258W-07	3.75	7.35
9	1258W-09	5.00	8.60
11	1258W-11	6.25	9.85
13	1258W-13	7.50	11.10
15	1258W-15	8.75	12.35
17	1258W-17	10.00	13.60
19	1258W-19	11.25	14.85
21	1258W-21	12.50	16.10
31	1258W-31	18.75	22.35
41	1258W-41	25.00	28.60

■ SPECIFICATIONS

- Voltage rating: 50V AC, DC
- Current rating: 1A, AC, DC
- Withstanding Voltage: 500V AC/minute
- Insulation resistance: 100MΩmin
- Temperature range: -25°C~+85°C
- Contact resistance: Intial value/10mΩmax
- After enviornmental testing/20mΩmax

■ WAFER

- Part No.: J1257WVS-XX
- Poles: 5,7,9,11,13,15,17,19,21,31,41
- Material: Nylon 6T UL94V-0
- Q'ty: 1000pcs/bag

							<p>一般公差 GENERAL TOLERANCE</p> <p>.X ±0.3</p> <p>.XX ±0.2</p> <p>.XXX ±0.1</p>				<p>东莞市翰皓精密电子有限公司 Dongguan HanHao Precision Electronics Co.,Ltd</p>				<p>料号 PART NO J1257WVS-XX</p>							
							<p>角法 PROJECT</p>				<p>品名 TITLE 1.25 mm Crimp Style connectors</p>											
2011/05/14							A		B		修改图框格式				核准 APPD		审核 CHK		绘图 DR		日期 DATA	
日期 DATE		旧版次 OLD REV		新版次 NEW REV		变更内容 DESCRIPTION				审核 CHK		核准 APPD		DK		SUCCESS		刘艳		2007/05/03		
单位 UNIT		比例 SCALE		图号 NUMBER		版次 REV		MM		1: 4		A-070		B								